



**RainPoint**<sup>®</sup> Smart  
More Than Water Saving

# USER MANUAL

## High Precision Rain Sensor

Model No. HCS012ARF

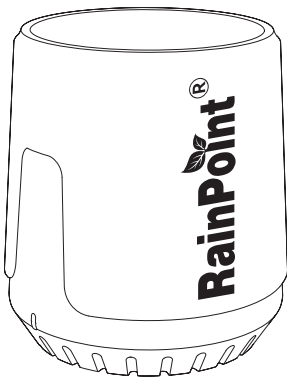

Welcome to the **RAINPOINT** family! Please read the manual before using to learn about the features and functions.

# Contents

<b>1. Contents in the box</b>	<b>01</b>
<b>2. Introduction</b>	<b>02</b>
2.1 Product Overview	02
2.2 Specification	02
2.3 Product Features	02
<b>3. Connection and Installation</b>	<b>03</b>
3.1 Rain Sensor Connection	03
3.2 Rain Sensor Installation	07
<b>4. App Features and Functions</b>	<b>08</b>
4.1 Device Home Page	08
4.2 Basic Setting	09
4.3 Charts	09
<b>5. Troubleshooting</b>	<b>10</b>
<b>6. Precautions</b>	<b>10</b>
<b>7. Warranty Policy</b>	<b>10</b>
<b>8. FCC Statement</b>	<b>11</b>
<b>9. Customer Support</b>	<b>12</b>

## 1. Contents in the box



1

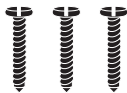

3

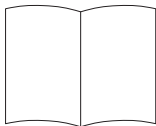

2

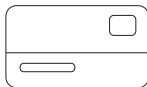

4

1. 1 X HCS012ARF High Precision Rain Sensor
2. 1 X User Manual
3. 3 X Stainless Steel Screw
4. 1 X Warranty Card

## 2. Introduction

### 2.1 Product Overview

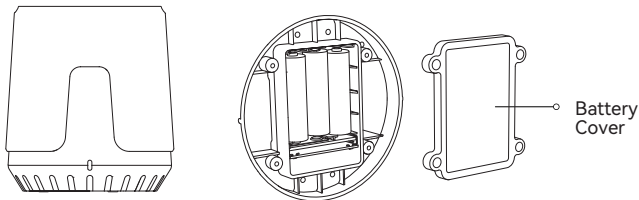

### 2.2 Specification

- **Weight:** 189g
- **Rainfall Range:** 0-9999mm
- **Accuracy:**  $\pm 0.1$ mm
- **Data Reporting:** Every 3 mins
- **Wireless Range:** 120m
- **Powered by:** 3\*AA batteries (Not included)

### 2.3 Product Features

- New rain bucket design, automatically drain rainwater.
- Real time rainfall accurate measurement, in/mm switchable.
- The rainfall records of 1h, 1 day and 1week, easy to check.
- Optimize mold design, suitable sized metal bracket for easier installation.
- Low battery indicator.

## 3. Connection And Installation

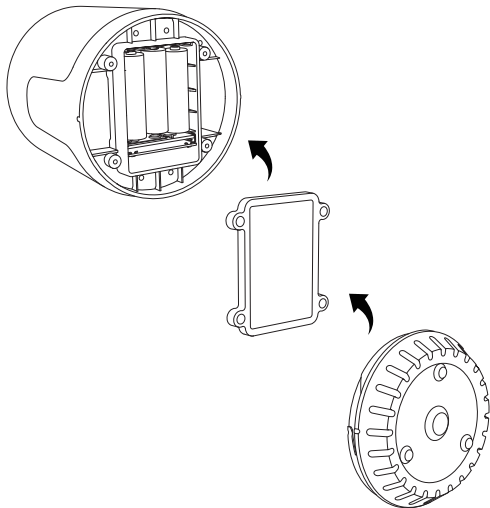

### 3.1 Rain Sensor Connection

1. Insert the batteries.

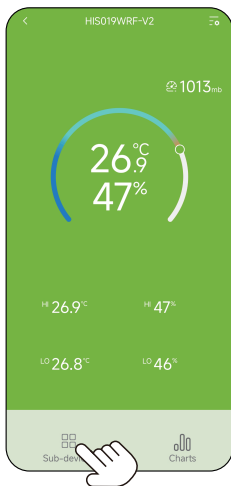
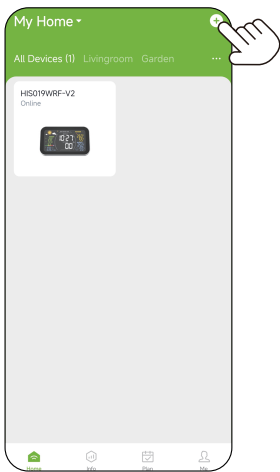

2. On the APP, select the **+** button on the top right corner of the APP home page to add device, or you can go to the hub's home page and use **"Sub-devices"** to add devices.



3. Enter the **"Add Device"** page, click on , or click on  in the upper right corner, scan the QR code in bottom of the manual or on the device to connect to network.

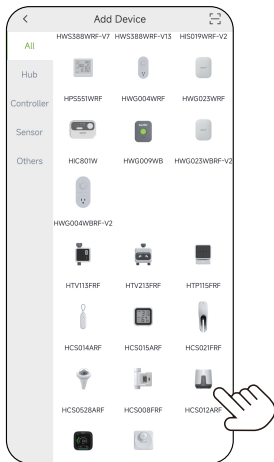

4. Select **"Next"** and start searching devices. At the same time, insert the batteries.

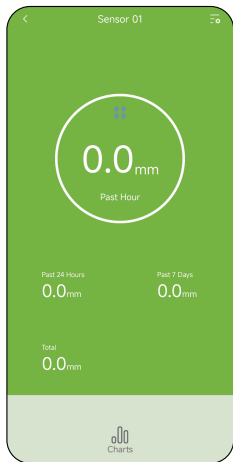

5. Keep the Rain Sensor and the hub close to each other so they can connect automatically.
6. After successfully connecting, precipitation for an hour is displayed in the middle of the screen, and precipitation for the last 24 hours, 7 days and the entire period is displayed at the bottom.

## 3.2 Rain Sensor Installation

1. Open the device, remove the internal transparent tape, and reinstall the device.

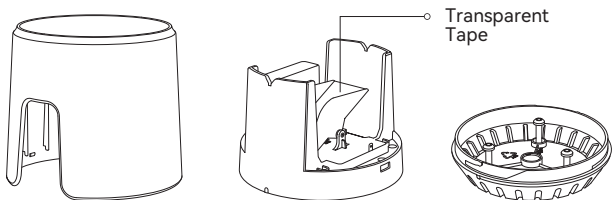

2. Horizontal placement.

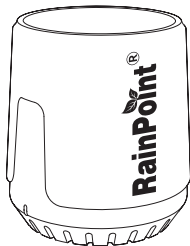

### Note:

1. Please try to place the rain barrel horizontally on a flat surface, not at an angle.
2. The equipment should be placed smoothly and should not be shaken otherwise it will affect the accuracy.

## 4. APP Features And Functions

### 4.1 Device Home Page

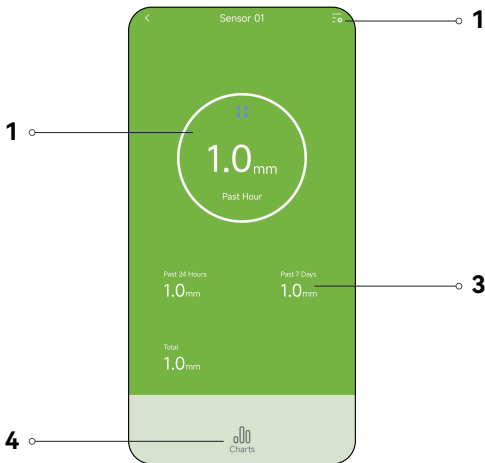

1. **Setting:** Basic settings for the Rain Sensor.
2. **Cumulative precipitation in one hour.**
3. **Cumulative precipitation for the past 24 hours, 30Days and 12Months.**
4. **Charts:** Check the accumulate data in bar Charts.

## 4.2 Basic Setting

In the basic settings, you can check and manage the device information, such as name, interface and description.

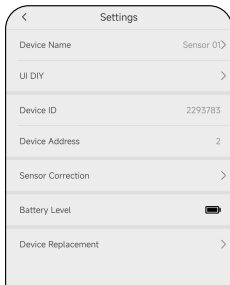

## 4.3 Charts

Select **Charts** to view the hourly, daily or monthly rainfall that has passed through this sensor.

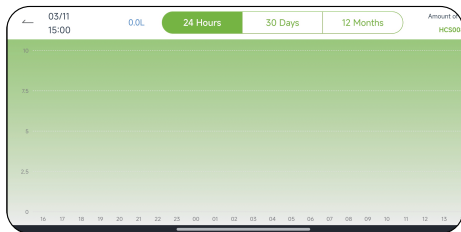

## 5. Troubleshooting

Problem	Possible Factors	Solution may help
Rain Sensor can't connect	<ul style="list-style-type: none"><li>• Unstable WiFi network.</li><li>• Long distance from the hub too far.</li></ul>	<ul style="list-style-type: none"><li>• Check that the WiFi network environment is working.</li><li>• Close to hubs and routers when connected to Rain Sensor.</li></ul>
Hub can't connect	<ul style="list-style-type: none"><li>• Not using 2.4GHz WiFi.</li><li>• Incorrect WiFi password.</li><li>• Distance between sensor and hub is too far.</li></ul>	<ul style="list-style-type: none"><li>• Confirm 2.4GHz WiFi connection.</li><li>• Confirm that the WiFi password has been entered correctly.</li><li>• Stay closer to the hub while connecting.</li></ul>

## 6. Precautions

1. Please make sure to use 2.4GHz band WiFi to connect to this product.
2. Do not mix old and new batteries or different types of batteries.
3. Please place the rain barrel horizontally to avoid inaccurate readings.

## 7. Warranty Policy

RainPoint provides a 1-year limited warranty on this product against manufacturing defects in materials and workmanship.

## 8. FCC Statement (FCC ID: 2AWDBHCS012ARF)

This device complies with Part 15 of the FCC Rules. Operation is subject to the following two conditions:

1. This device may not cause harmful interference.
2. This device must accept any interference received, including interference that may cause undesired operation.

**FCC Warning:** Any changes or modifications not expressly approved by the party responsible for compliance could void the user's authority to operate this equipment.

**Note:** This equipment has been tested and found to comply with the limits for a Class B digital device, pursuant to Part 15 of the FCC Rules. These limits are designed to provide reasonable protection against harmful interference in a residential installation. This equipment generates, uses, and can radiate radio frequency energy, if not installed and used in accordance with the instructions, may cause harmful interference to radio communications. However, there is no guarantee that interference will not occur in a particular installation. If this equipment does cause harmful interference to radio or television reception, which can be determined by turning the equipment off and on, the user is encouraged to try to correct the interference by one of the following measures:

- Reorient or relocate the receiving antenna.
- Increase the separation between the equipment and the receiver.
- Connect the equipment into an outlet on a circuit different from that to which the receiver is connected.
- Consult the dealer or an experienced radio/TV technician for help.

**Note:** The manufacturer is not responsible for any radio or TV interference caused by unauthorized modifications to this equipment. Such modifications could void the user's authority to operate the equipment.

## 9. Customer Support

If you find it difficult to set up and want to watch the setting tutorial video, please subscribe to our channel RainPoint on YouTube.



Or scan the QR code to visit the RainPoint channel on YouTube quickly.

If the app and the user manual don't have what you're looking for, and need some help about Rainpoint, please contact us by  
**LOT NO.:** XXXXXX (on the back of the device)

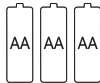

Not included



Points de collecte sur [www.quefairedemesdechets.fr](http://www.quefairedemesdechets.fr)  
Privilégiez la réparation ou le don de votre appareil !



## Need Help ?

Scan the QR code for more help.



or Email:

[support@rainpointonline.com](mailto:support@rainpointonline.com)